



LENSTAR 900

Improving outcomes

Tradition and Innovation – Since 1858, visionary thinking and a fascination with technology have guided us to develop innovative products of outstanding reliability: Anticipating trends to improve the quality of life.



02 | 03 LENSTAR 900

LENSTAR

Outstanding optic measurement results

While the introduction of optical biometry revolutionized cataract surgery in the late 1990s, Haag-Streit is writing the latest chapter in biometry history with its Lenstar 900.

The Lenstar provides highly accurate laser optic measurements for every section of the eye – from the cornea to the retina – and is the first optical biometer on the market that can measure the thickness of the crystalline lens. With its integrated Hill-RBF, Olsen and Barrett formulas and the optional IOL Toric Planner considering the posterior cornea, the Lenstar provides the user with latest technology in IOL prediction for any patient.

Dual zone keratometry, with 32 measurement locations or topography measurement with the optional T-Cone, provides reliable and precise measurements for the K values, axis, and astigmatism that are essential to the sophisticated planning of toric lenses^{2,3}. The Lenstar 900 offers the optimal planning platform for superior refractive outcomes in cataract surgery, both now and in the future.



Precise measuring data for the Hill-RBF Method

Lenstar's precise measurement technique in combination with the unique Hill-RBF Method allows accurate prediction of the IOL power for every type of eye. To improve refractive outcomes, Lenstar is the optimal choice.

Perfect K values – best toric results

The Lenstar features dual zone keratometry or T-Cone topography for precise astigmatism and axis measurement^{2,3}. The integrated Toric Calculator featuring Barrett¹², Hill-RBF and Olsen predicts toric IOL, considering the posterior cornea for best refractive outcomes.

For post-refractive cases – quick and reliable

Barrett True-K, Shammas No-History and Masket IOL calculation methodologies can be used for post-refractive patients even without any clinical history available^{5,6,13}.



04 | 05 EXPERT OPINION

LENSTAR an excellent choice for toric and premium channel IOL

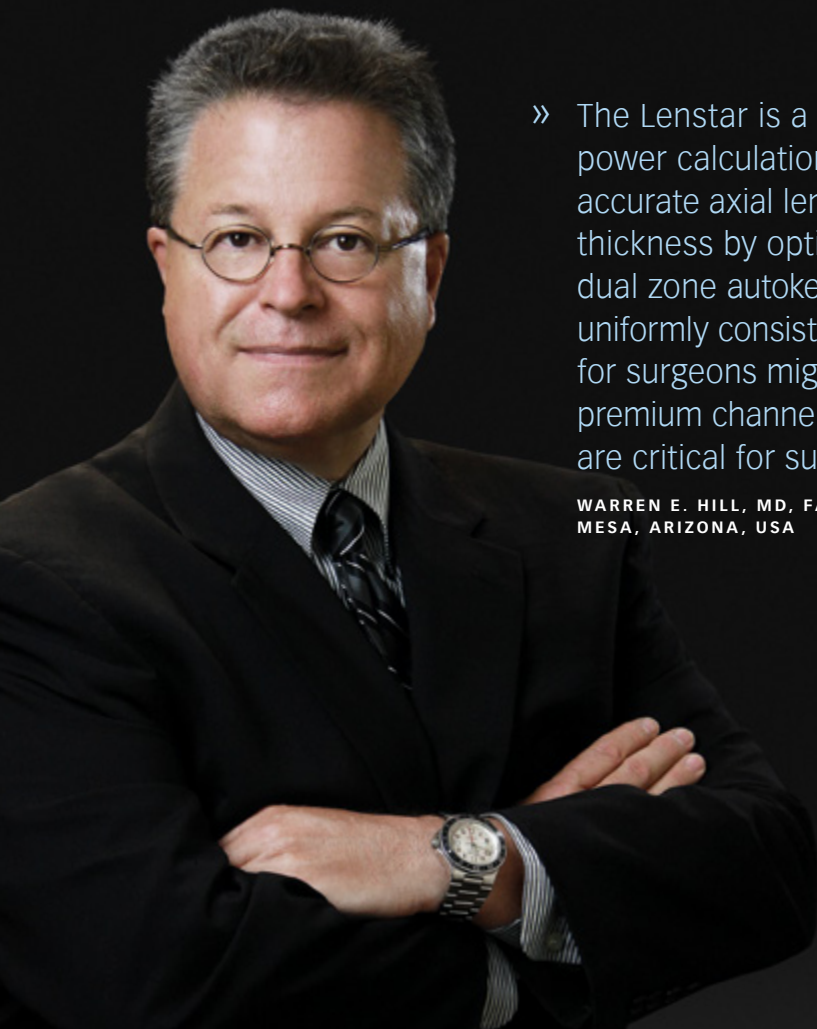

» The Lenstar is a remarkably easy to use all-in-one IOL power calculation tool that delivers exceptionally accurate axial length, anterior chamber depth and lens thickness by optical biometry. At the same time, its dual zone autokeratometry feature is precise and uniformly consistent. The Lenstar is an excellent choice for surgeons migrating towards torics and other premium channel IOLs where highly accurate outcomes are critical for success. «

WARREN E. HILL, MD, FACS
MESA, ARIZONA, USA



T-CONE

Topography for torics – match the axis

With the optional T-Cone toric platform, the axis and astigmatism measurement of Lenstar is extended with true 11-ring Placido topography. This additional data improves the efficacy and safety of toric IOL surgery, eliminating the risk of irregularities and allowing the user to double check the axis location on the topography maps as well as in the surgical planning sketch on high resolution images of the patient's eye. The T-Cone is combined with the EyeSuite IOL Toric Planner for optimal planning of the intervention based on the Barrett Toric Calculator.

DUAL ZONE KERATOMETRY OR T-CONE TOPOGRAPHY

Precise measurements and intuitive planning – best toric results

Lenstar's unique dual zone keratometry provides measurement of the axis and astigmatism, equivalent to the "Gold Standard" manual keratometry^{2,3} recommended for toric IOL by manufacturers.

The closely spaced 32 measurement point pattern improves precision, both delivering more data and minimizing the need for software data interpolation.

Optionally, the Lenstar can be equipped with the T-Cone topography add-on. That feature not only enables axis and astigmatism measurement but also offers full topography maps of the central 6 mm optical zone. In addition to topography, EyeSuite IOL also now features a toric IOL planning platform that is included with the T-Cone.

QUICK AND RELIABLE BIOMETRY FOR ALL EYES

Fast, precise and comprehensive for better refractive results

The measurement process of the Lenstar is fast and optimized to ensure maximum patient comfort – users report five scans of both eyes in three minutes or less, optional the Automated Positioning System (APS) features dynamic eye-tracking allowing easy automated measurement acquisition with a single click. The Dens Cataract Measurement (DCM) Mode ensures state-of-the-art cataract penetration. Each of the measurements can be validated for efficacy and adjusted, if necessary, to ensure complete biometry accuracy.

In addition to the Hill-RBF, Barrett, Olsen and standard IOL calculation formulae EyeSuite IOL provides the user with a set of premium IOL calculation formulae for post-keratorefractive patients. Barrett True-K, Shammas No-History, and Masket formulae have proven their efficacy in several peer-reviewed studies and may be regarded as best-in-class^{5,6,13}.



T-CONE

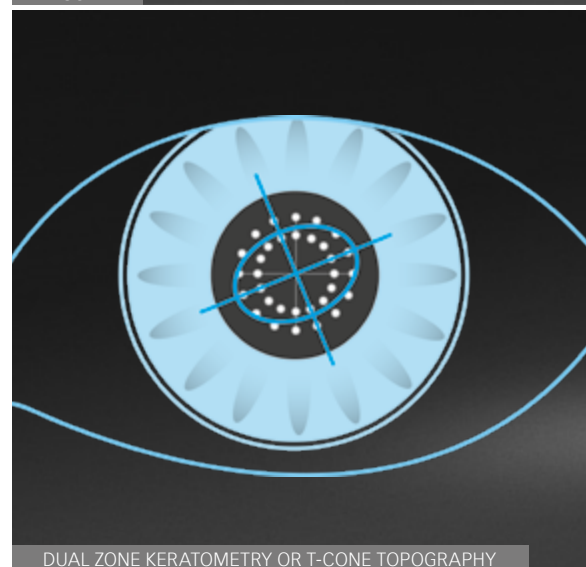

DUAL ZONE KERATOMETRY OR T-CONE TOPOGRAPHY



APS – EFFICIENT AND ACCURATE

06 | 07 LENSTAR MEASUREMENTS

Complete optical biometry **The all-in-one optical biometer and IOL planning platform**

Optical coherence biometry has revolutionized cataract surgery. Featuring OLCR technology, Lenstar is redefining optical coherence biometry.

Cutting-edge, multivariable IOL calculation formulae, such as the Olsen, Barrett, Holladay 2 formula or Hill-RBF Method for sophisticated IOL calculation, demand more than just the axial length and keratometry measurement. Lenstar provides all the key biometric parameters simultaneously.

In a single measurement scan and using optical low coherence reflectometry (OLCR), Lenstar captures axial dimensions of all of the human eye's optical structures. Additionally, Lenstar measures corneal curvature, white-to-white and more.

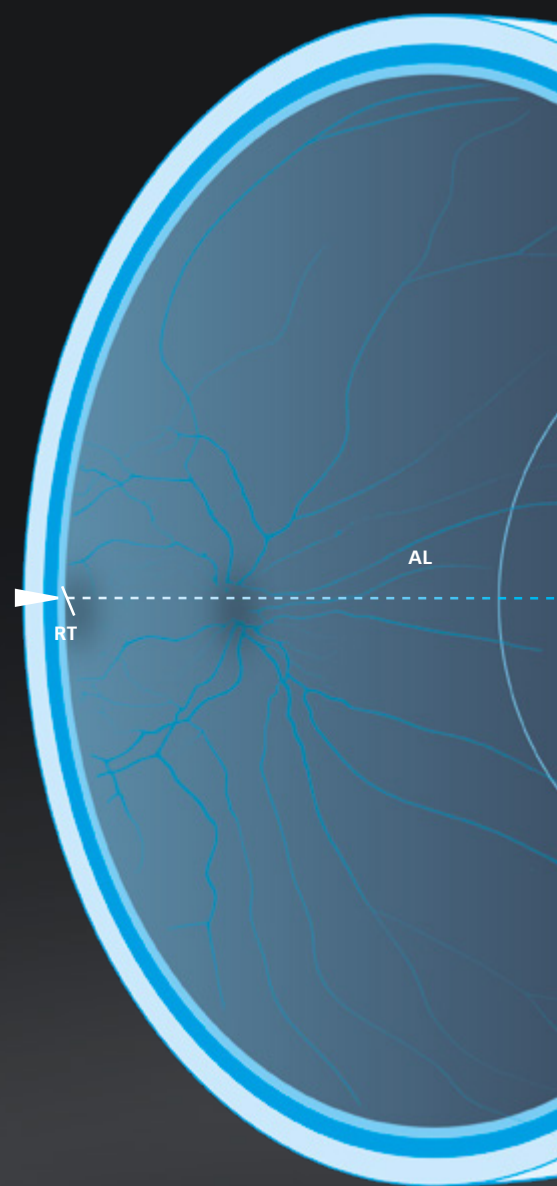

Central corneal thickness^{CCT}

As for every other Lenstar axial measurement, optical coherence biometry is used to measure CCT with stunning reproducibility of $\pm 2\mu\text{m}$. CCT is a key parameter in glaucoma diagnosis, and is also used for laser refractive surgery and/or to differentiate prior myopic or hyperopic LASIK procedures when there is no patient history.

Keratometry^K / Topography^{Topo}

Lenstar's unique dual zone keratometry, featuring 32 marker points, provides perfect spherical equivalent⁷, magnitude of astigmatism and axis position^{2,3}, making it the biometer of choice for toric IOL's. With the optional T-Cone topography add-on, Lenstar provides full topography maps of the central 6mm optical zone that are crucial for cataract planning.

White-to-white^{WTW}

Based on high-resolution color photography of the eye, every white-to-white measurement can be reviewed and adjusted by the user if necessary. As such, it is fully reliable for use with anterior chamber and sulcus-fixated phakic IOLs. It can also be used to determine advanced IOL calculation formulae.

Pupillometry^{PD}

Measurement of the pupil diameter in ambient light conditions can be used as an indicator for the patient's suitability for apodized premium IOLs, as well as for laser refractive procedures.

Lens thickness^{LT}

Accurate measurement of the lens thickness is key to optimal IOL prediction accuracy when using the latest IOL calculation formulae, Olsen or Holladay 2. Measuring the lens thickness with Lenstar significantly improves the IOL prediction accuracy of Holladay 2 and leads to a different IOL power selection in 30% of cases⁴.

Anterior chamber depth^{ACD}

Like all axial dimensions captured by the Lenstar, ACD is measured by optical coherence biometry, providing more precision and reproducibility⁷. This allows ACD to be measured on phakic as well as on pseudophakic eyes⁸. Additionally, the Lenstar is able to display the anatomical anterior chamber depth (endothelium to anterior lens surface).

Axial length^{AL}

OLCR technology, using a superluminescent diode as the laser source, enables measurement of the axial length of the patient's eye, precisely on the patient's visual axis and in the presence of dense media.

The user can review and move all of the measuring gate positions on the A-scan if necessary.

The Lenstar A-scan appears very similar to an immersion ultrasound scan, for easy user interpretation. The advanced digital signal processing used with the Dens Cataract Measurement (DCM) mode provides cutting-edge performance with respect to penetration rates.

Special eye conditions

All of the described measurements are available for use on the regular eye, as well as for aphakic, pseudoaphakic and silicone oil-filled eyes. In case of error, users may even change the selected eye condition after completion of the measurement procedure.

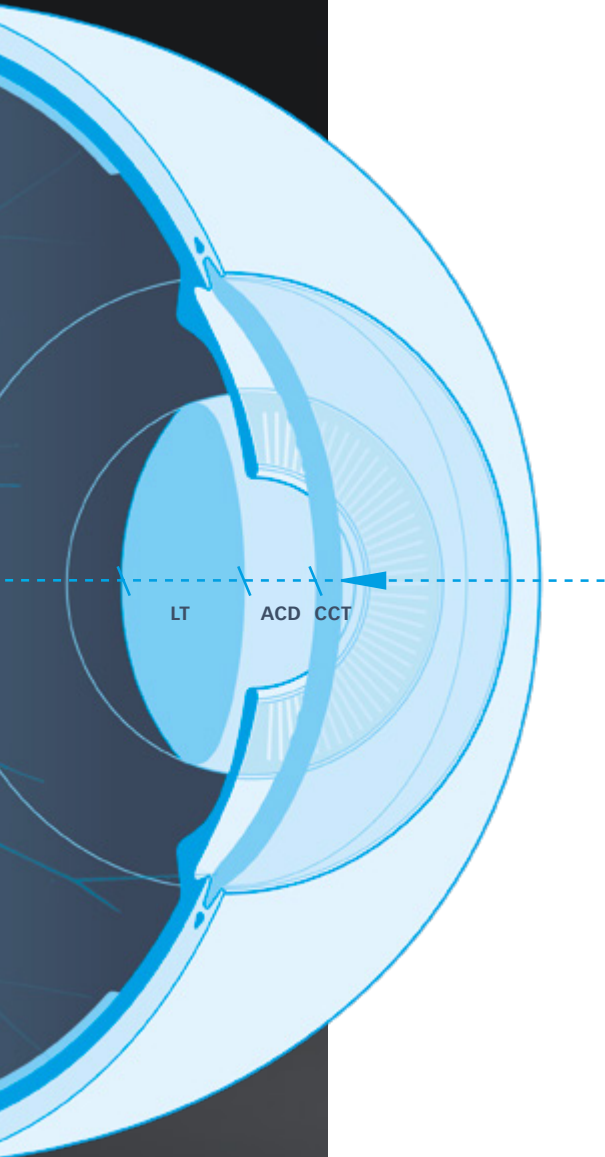

Intuitive and efficient The ultimate platform for toric IOL planning

Lenstar features a unique dual zone keratometer with a total of 32 marker points on two concentric rings of 1.65 and 2.3mm in diameter for improved refractive outcomes with toric lenses^{2,3}. It has now been complemented with an optional T-Cone topography add-on and the optional toric surgery planning platform EyeSuite IOL Toric Planner. The T-Cone enables the Lenstar to provide true Placido topography of the central 6mm optical zone. The toric surgery planning platform allows planning and optimization of the surgical procedure based on high-resolution and true color eye images taken with the Lenstar, either in combination with the T-Cone, or simply based on the dual zone keratometry of the standard unit. The IOL Toric Planner shows the implantation axis, the incision location and user-defined guiding meridians in the real patient image. Calculation of the toric IOL performed with the Barrett Toric Calculator, considers the front and back surface of the cornea as

well as lens shape for optimum calculation results. The Barrett Toric Calculator demonstrated its superiority in studies^{12,14} and is the choice of the ASCRS as well as the APACRS for their on-line toric calculators.

Incision optimization tools allow for precise placement of the incision to minimize the residual astigmatism based on the surgically induced astigmatism. Alternatively, the incision location is fixed and the optimal toric IOL is provided.

Planning of the operation on real eye images allows the user to define recognizable, additional guiding lines to anatomical landmarks in the intraoperative view. They either serve as a base line point for the intraoperative orientation or as a fallback strategy if external marking is not successful. The planning sketch can easily be printed and hung near the microscope.

BARRETT

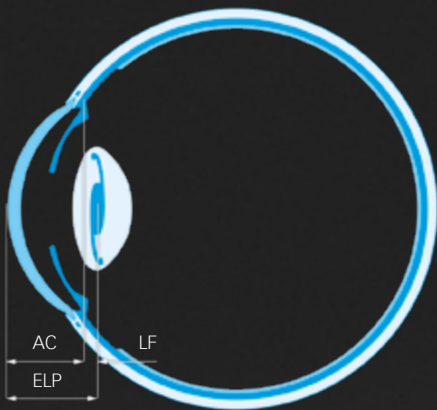

HILL-RBF METHOD

A new approach for IOL power selection

The Hill-RBF Method is a purely data driven IOL calculation technique incorporating pattern recognition based in artificial intelligence and sophisticated data interpolation. It features a boundary model for improved accuracy and confidence. RBF stands for Radial Basis activation Function a method used in mathematical modeling. The Hill-RBF Method performs as good in short and long eyes¹⁵. Used on short eyes, it clearly outperforms Holladay¹⁶ and Hoffer Q¹⁶ and shows slightly better results than latest theoretical formula¹⁶. The elemental advantage is achieved through the process of adaptive, dynamic learning. Unlike static theoretical formulae, the Hill-RBF Method is an ongoing project and is continuously updating for an even better overall depth of accuracy.

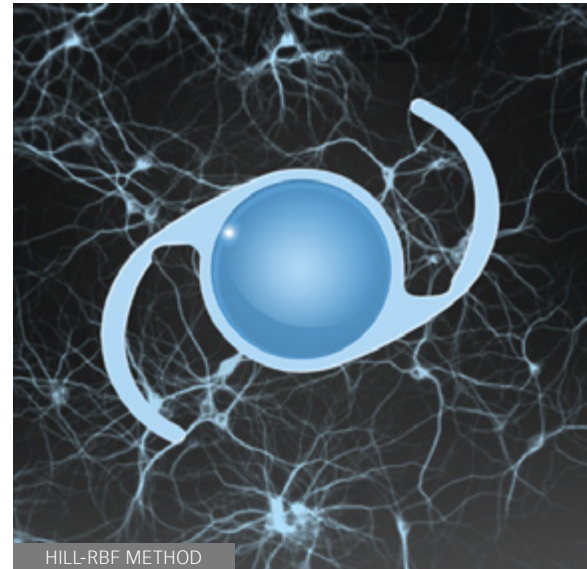

HILL-RBF METHOD

OLSEN

Get the IOL position right – every time

Estimating the postoperative IOL position is the key aim, but also the proverbial Achilles heel, of any IOL calculation formula. With its unique concept of the C-Constant, the Olsen formula calculates the postoperative lens position as a fraction of the crystalline lens thickness and the ACD. This approach allows accurate calculation of the lens position independent of the corneal status of the eye. The lens position is then used to calculate the IOL power based on ray tracing, the same technology used to design telescopes and camera lenses.

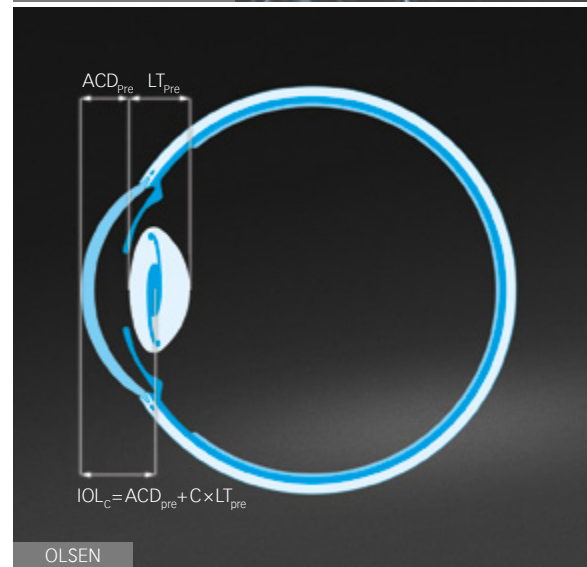

OLSEN

Barrett True-K, Shammas No-History and Masket – for premium results

The EyeSuite software for Lenstar provides the user with a comprehensive set of cutting-edge IOL calculation formulae for normal eyes. IOL Power calculation in patients with prior RK, LASIK or PRK, presenting with no history, is easily achieved with the on-board Barrett True-K and Shammas No-History method.^{5,6,13} If the change in refraction is known, then the Barrett True-K with history, Masket and modified Masket formulae^{5,6,13} may also be used.

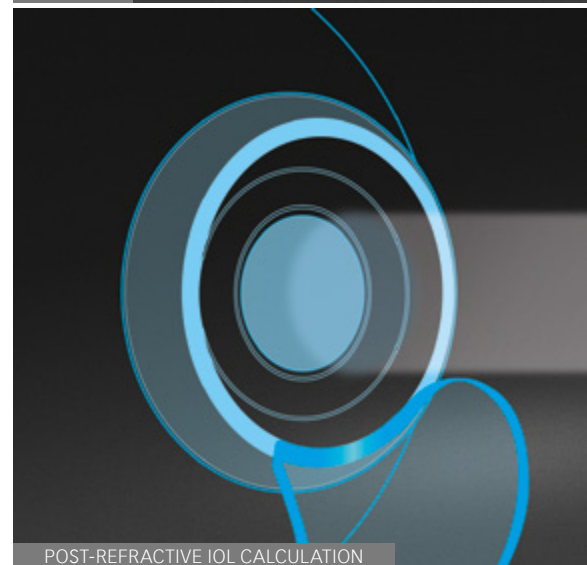

POST-REFRACTIVE IOL CALCULATION

Connectivity is key Open data and intuitive user interfaces for optimal workflow

The EyeSuite software is designed for optimal patient flow in busy practices. Paired with Lenstar's one scan – get all measurements technology and the Automated Positioning System APS biometry acquisition is fast.

Sophisticated capture and analysis algorithms – as well as the possibility to review the raw data of every parameter in detail to ensure correct measurement – result in full transparency and confidence that the biometry is accurate and precise.

With EyeSuite software, Lenstar is fully networkable and allows full real-time access to all data in a practice. Surgeons can check their biometry results or recalculate an IOL even in the OR.

Further, the EyeSuite script language or standardized interfaces, such as GDT or DICOM, connect easily to almost any electronic medical record system. And EyeSuite's open data interface, combined with Lenstar's separate computer, allows auto-population of the data fields in the latest fourth generation calculation tools – such as Holladay 2, the Holladay toric calculator (Holladay IOL Consultant) and Olsen (PhacoOptics). This not only saves valuable staff time, it also eliminates the risk of transcription errors.

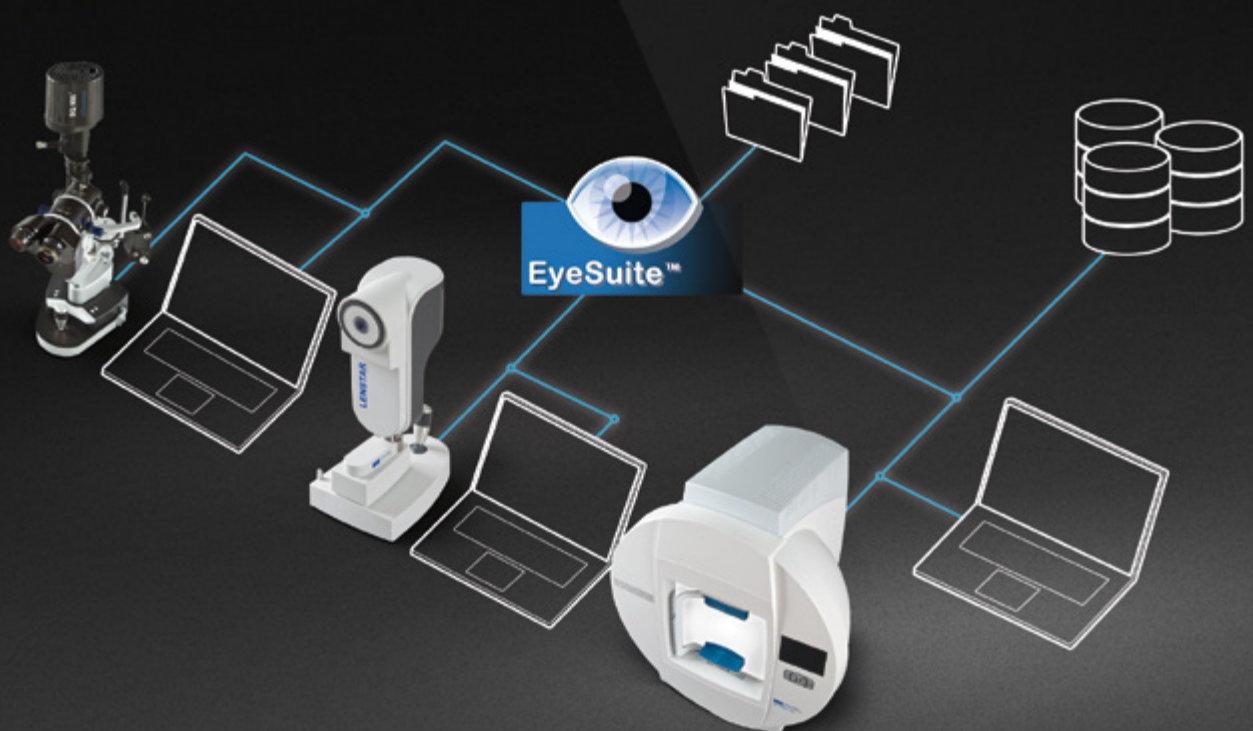

Your choice Lenstar family and options, get the right tool for your needs

The Lenstar is now available in two basic versions: Lenstar Essential and Lenstar Pro.

The Lenstar Essential provides all basic functionalities of a stand-alone optical biometer for standard cataract care in a busy practice. As such the Lenstar Essential features the unique Automated Positioning System (APS) as a standard, allowing automatic measurement acquisitions at a single click. A Lenstar Essential may be upgraded on site to Pro at any time, offering the full range of functionality of the Pro version and access to all options available.

The Lenstar Pro features latest IOL calculation methodologies and more, for advanced technology IOL planning and allows access to all options like the T-Cone Toric Platform or the EyeSuite IOL Toric Planner. Furthermore it provides the user with full control over all raw measurements for quality check and with the

possibility to easily export any measurement data for research purposes. Networkability is another feature of the Pro version allowing access to the measurements and IOL calculation from any PC in the practice.

Options to the Lenstar Pro are the T-Cone Toric Platform, providing true Placido Topography of the central 6 mm of the cornea for the comprehensive planning of toric IOL, combined with the EyeSuite IOL Toric Planner, which is available as an independent option as well. The Toric planner enables the user to calculate the toric IOL based on the Barrett Toric Calculator and to draw operation sketches based on high resolution eye images of the patient. The sketches feature axis of implantation, flat and steep meridian of the cornea, incision location and size, as well as location of user selected anatomic landmarks for accurate transfer of the plan to surgery.



		Lenstar 900 Essential	Lenstar 900 Pro
Operation	Multi user system	■	■
	Dense Cataract Measurement Mode (DCM)	■	■
	Automated Positioning System (APS)	■	○
Measurements	Axial length (AL)	■	■
	Central corneal thickness (CCT)		■
	Anterior chamber depth (ACD)	■	■
	Anatomic ACD (AD)		■
	Lens thickness (LT)		■
	Keratometry (K)	■	■
	Topography (Topo)		○*
	White to white (WTW)	■	■
	Pupillometry (PD)	■	■
	Quality control	Display of standard deviation of repeated measurements	■
Access to A-scan and imaging data			■
Manual adjustments of measurement gates			■
IOL Calculation	Hill-RBF Method		■
	Hill-RBF / Abulafia Koch Toric		■
	Barrett Universal II	■	■
	Barrett True-K	■	■
	Barrett Toric Calculator		■
	Haigis	■	■
	HofferQ	■	■
	Holladay 1	■	■
	Olsen		■
	SRK II and SRK/T	■	■
	Masket / Modified Masket	■	■
	Shammas No-History	■	■
	IOL constants	Personalisation of IOL constants	■
Networkability	Electronic medical record interfaces (EyeSuite Script Language, GDT, EyeSuite Command Line Interface)	■	■
	DICOM (SCU)	○	○
	IOL calculation on additional workstations		■
	EyeSuite viewing stations		■
		■ included	○ optionally available

all Lenstar Pro features and options are available to Lenstar Essential users after an upgrade to Pro, which is possible on site at any time

○* This option is part of the T-Cone Toric Platform

Technical specifications

Lenstar LS 900

Measured variables and modes

Corneal thickness^{CT}

Measurement range	300–800 µm
Display resolution	1 µm

Anterior chamber depth^{ACD}

Measurement range	1.5–6.5 mm
Display resolution	0.01 mm

Lens thickness^{LT}

Measurement range	0.5–6.5 mm
Display resolution	0.01 mm

Axial length^{AL}

Measurement range	14–32 mm
Display resolution	0.01 mm

White-to-white distance^{WTW}

Measurement range	7–16 mm
Display resolution	0.01 mm

Keratometry^K

Measurement range	
for radius	5–10.5 mm
Display resolution	0.01 mm
Measurement range	0–180°
for axis angle	
Display resolution	1°

Pupillometry^{PD}

Measurement range	2–13 mm
Display resolution	0.01 mm

Measurement modes

'Normal' eye
Aphakic eye
Pseudophakic eye
Silicone-filled eye
Combination of the above

Laser safety

Class 1 laser product

Onboard IOL calculation formulae

Hill-RBF Method, Hill-RBF/Abulafia-Koch Toric Calculator, Olsen, Barrett Universal II, Barrett True-K, Barrett Toric Calculator, Haigis, HofferQ, Holladay 1, SRK/T, SRK II, Masket, Modified Masket, Shammas No-History

IOL calculation data interfaces

- Holladay IOL Consultant Professional Edition (Holladay 2 formula and Holladay toric calculator)⁹
- PhacoOptics (Olsen formula)¹⁰
- Okulix (Ray-Tracing by Prof. Preussner)¹¹

Electronic medical record system interfaces

- DICOM (SCU)
- EyeSuite Script Language
- GDT
- EyeSuite command line interface

The above-mentioned measurement ranges are based on the standard settings of the device for automatic measurement and analysis.

LENSTAR LS 900 Optical Biometer Indications for Use

The Lenstar LS 900 Biometer is a non-invasive, non-contact OLCR (Optical Low Coherence Reflectometry) device. It is used for obtaining ocular measurements and performing calculations to assist in the determination of the appropriate power and type of IOL (intraocular lens) for implantation after removal of the natural crystalline lens following cataract removal.

The LENSTAR LS 900 measures:

- Axial eye length
- Corneal thickness
- Anterior chamber depth
- Aqueous depth
- Lens thickness
- Corneal curvature
- Radii for flat and steep meridian
- Axis of the flat meridian
- White-to-white distance
- Pupil diameter

1 Olsen T. Improving IOL power Calculation by measurement of the lens thickness with the Lenstar LS900 presented at the ESCRS in Paris 2010. **2** Hill W, Osher R, Cooke D, Solomon K, Sandoval H, Salas-Cervantes R, Potvin R. Simulation of toric intraocular lens results: manual keratometry versus dual zone automated keratometry from an integrated biometer. *J Cataract Refract Surg.* 2011 Dec; 37(12): 2181-7. **3** Gundersen KG, Potvin R. Prospective study of toric IOL outcomes based on the Lenstar LS 900 dual zone automated keratometer. *BMC Ophthalmol.* 2012 Jul 16; 12:21. **4** Lam S. Comparison of Age-derived Lens Thickness to Optically Measured Lens Thickness in IOL power Calculation: A Clinical Study. *J Refract Surg.* 2012 Feb; 28(2): 154-5. **5** Wang L, Hill WE, Koch DD. Evaluation of intraocular lens power prediction methods using the American Society of Cataract and Refractive Surgeons Post-keratorefractive Intraocular Lens power Calculator. *J Cataract Refract Surg.* 2010 Sep; 36(9): 1466-73. **6** McCarthy M, Gavanski GM, Paton KE, Holland SP. Intraocular lens power calculations after myopic laser refractive surgery: a comparison of methods in 173 eyes. *Ophthalmology.* 2011 May; 118(5): 940-4. **7** Buckhurst PJ, Wolffsohn JS, Shah S, Naroo SA, Davies LN, Berrow EJ. A new optical low coherence reflectometry device for ocular biometry in cataract patients. *Br J Ophthalmol.* 2009 Jul; 93(7): 949-53. **8** Olsen T. Use of fellow eye data in the calculation of intraocular lens power for the second eye. *Ophthalmology.* 2011 Sep; 118(9): 1710-5. **9** <http://www.hicsoap.com/> accessed March 16, 2015. **10** <http://www.phacooptics.com/> accessed March 16, 2015. **11** <http://okulix.de/> accessed March 16, 2015. **12** Barret G. Flight of the arrow: improving outcomes with toric intraocular lenses, XXXII Congress of the ESCRS 2014 London, Video Prize Winner, Category Innovation, available on escres on demand, <http://escrs.conference2web.com/content/23476/> accessed March 16, 2015. **13** Wang L, Tang M, Huang D, Weikert MP, Koch DD. Comparison of Newer Intraocular Lens Power Calculation Methods for Eyes after Corneal Refractive Surgery. *Ophthalmology.* 2015 Dec; 122(12): 2443-9. **14** Abulafia A, Barrett GD, Kleinmann G, Ofir S, Levy A, Marcovich AL, Michaeli A, Koch DD, Wang L, Assia EI. Prediction of refractive outcomes with toric intraocular lens implantation. *J Cataract Refract Surg.* 2015 May; 41(5): 936-44. **15** W.E. Hill; IOL Power Selection by Pattern Recognition; ASCRS EyeWorld Corporate Education; ASCRS 2016. **16** M.E. Snyder; The Hill-RBF Method in Clinical Practice; ASCRS EyeWorld Corporate Education; ASCRS 2016

HAAG-STREIT AG

Gartenstadtstrasse 10
 3098 Koeniz
 Switzerland
 Phone +41 31 978 01 11
 Fax +41 31 978 02 82
 info@haag-streit.com
 www.haag-streit.com

Members of HAAG-STREIT Group

HAAG-STREIT Holding AG
 www.haag-streit-holding.com

CLEMENT CLARKE Ltd.
 www.clement-clarke.com

HAAG-STREIT AG, Diagnostics
 www.haag-streit.com

HS DOMS GmbH
 www.hs-doms.com

HAAG-STREIT AG, Verkauf Schweiz
 www.haag-streit.ch

IPRO GmbH
 www.ipro.de

HAAG-STREIT Deutschland GmbH
 www.haag-streit.de

John Weiss Ltd.
 www.johnweiss.com

HAAG-STREIT Far East
 www.haag-streit-fareast.com

Möller-Wedel GmbH & Co KG
 www.haag-streit-surgical.com

HAAG-STREIT Medtech AG
 www.haag-streit-medtech.com

Möller-Wedel Optical GmbH
 www.moeller-wedel-optical.com

HAAG-STREIT Surgical GmbH
 www.haag-streit-surgical.com

OptoMedical Technologies GmbH
 www.haag-streit-surgical.com

HAAG-STREIT UK
 www.haag-streit-uk.com

Reliance Medical Inc.
 www.haag-streit-usa.com

HAAG-STREIT USA
 www.haag-streit-usa.com

SPECTROS AG
 www.spectros.ch